

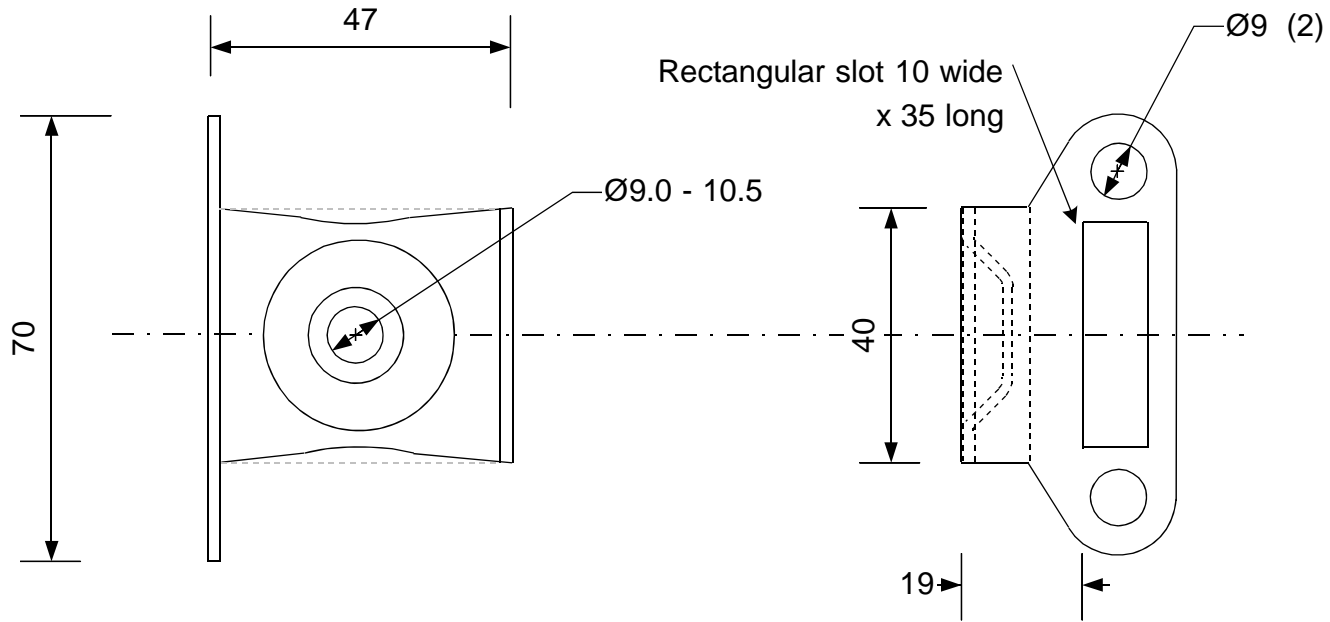

Product Data Sheet

DOOR LOCK BRACKET- RPN 0200

Application : Fixing system for retaining Door Enclosures



SECTIONAL VIEW

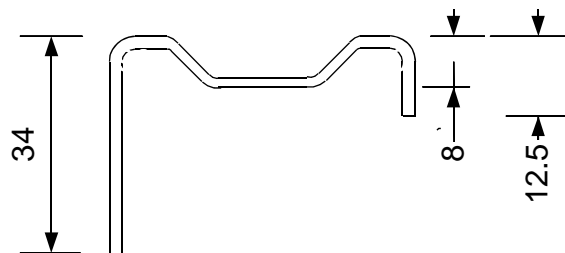

All dimensions in Millimetres

Material - Low carbon Steel to EN 10130 FePo4 - 2mm Thick

Finish - Self Colour

The Regent Engineering Co. (Walsall) Ltd Salisbury Street Darlaston Wednesbury West Midlands WS10 8XB UK

E-mail : info@regenteng.com

Web : www.regenteng.com

Phone 44 (0)121 526 6060

Fax : 44(0)121 526 4789

© 2005